

Cover for Holder OGN



4W/10A

See below:
[Approvals and Compliances](#)

Description

- Cover for OGN fuseholders
- Available in different colors and materials
- Heat-resistant variant available for reflow soldering

References

Mating cover to [OGN](#); [OGN Pre-Assembled](#)

Weblinks

[pdf data sheet](#), [html datasheet](#), [General Product Information](#), [Distributor-Stock-Check](#), [Detailed request for product](#), [Microsite](#)

Technical Data

Fuse-Link	5 x 20mm
Rated Power Acceptance IEC	4 W / 10 A @ Ta 23 °C 2.5 W / 10 A with transparent cover
Admissible Ambient Temp.	-40 °C to 85 °C
Material: Cover	Thermoplastic UL 94V-0
Storage Conditions	0 °C to 60 °C, max. 70% r.h.



Approvals and Compliances

Detailed information on product approvals, code requirements, usage instructions and detailed test conditions can be looked up in [Details about Approvals](#)

SCHURTER products are designed for use in industrial environments. They have approvals from independent testing bodies according to national and international standards. Products with specific characteristics and requirements such as required in the automotive sector according to IATF 16949, medical technology according to ISO 13485 or in the aerospace industry can be offered exclusively with customer-specific, individual agreements by SCHURTER.



Product standards

Product standards that are referenced

Organization	Design	Standard	Description
	Designed according to	IEC 60127-6	Miniature fuses. Part 6. Fuse-holders for miniature fuse-links
	Designed according to	UL 4248-1	Industrial Control Equipment
	Designed according to	CSA C22.2 no. 4248.1	Industrial Control Equipment





Application standards

Application standards where the product can be used

Organization	Design	Standard	Description
	Suitable for applications acc.	IEC/UL 62368-1	Audio/video, information and communication technology equipment - Part 1: Safety requirements
	Suitable for applications acc.	IEC 60335-1	Safety of electrical appliances for household and similar purposes. Meets the requirements for appliances in unattended use. This includes the enhanced requirements of glow wire tests acc. to IEC 60695-2-11 or -12 & -13.

Compliances

The product complies with following Guide Lines

Identification	Details	Initiator	Description
	RoHS	SCHURTER AG	Directive RoHS 2011/65/EU, Amendment (EU) 2015/863
	China RoHS	SCHURTER AG	The law SJ / T 11363-2006 (China RoHS) has been in force since 1 March 2007. It is similar to the EU directive RoHS.
	REACH	SCHURTER AG	On 1 June 2007, Regulation (EC) No 1907/2006 on the Registration, Evaluation, Authorization and Restriction of Chemicals 1 (abbreviated as "REACH") entered into force.
	White Paper Glow wire test	SCHURTER AG	Meets the requirements of IEC 60335-1 for appliances in unattended use. This includes the enhanced requirements of glow wire tests acc. to IEC 60695-2-11 or -12 &-13.

Dimension [mm]

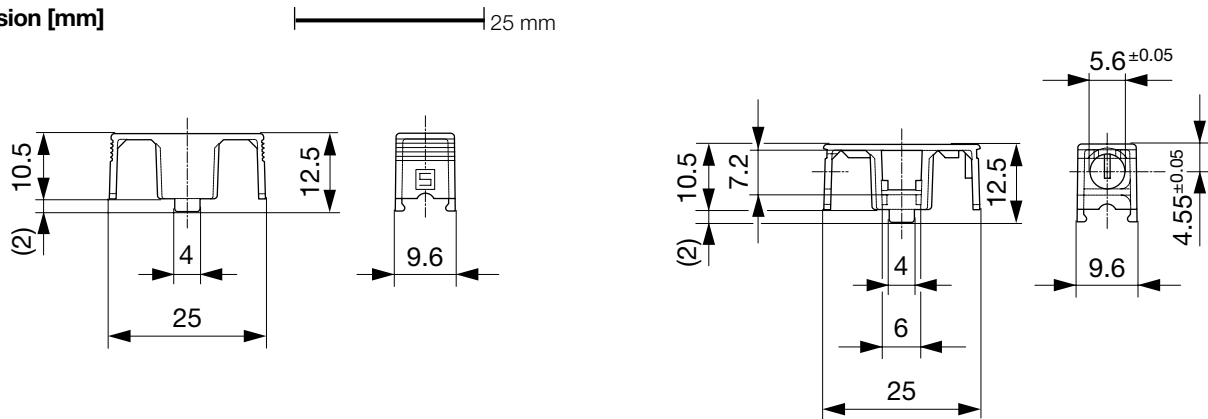

Variants 0853.0551, 0853.0571, 0853.0573 and 0853.0575

Variant 0853.0576

Accessories	Description	Color	Order Number
Cover	for 245 °C Reflow	black	0853.0571
Cover	for 260 °C Reflow	black	0853.0573
Cover	black (not for reflow)	black	0853.0575
Cover	with Clamp for 245 °C Reflow	black	0853.0576
Cover	Transparent (not for reflow)	transparent	0853.0551

 Most Popular.

Availability for all products can be searched real-time: <https://www.schurter.com/en/info-center/support-tools/stock-check-distributors>

Packaging Unit

Bulk (100 pcs.)