

Shock-Safe Fuseholder, 5 x 20 mm, Slotted Cap/Fingergrip, horizontal, PC3, medical



shuttered
 from front side
 horizontal with slot



Closed fuseholder 5 x 20 mm
 horizontal with finger grip
 captive fuse carrier



open
 from front side
 horizontal with slot

250 VAC · 1.6W/6.3A (VDE)10A (UL/CSA)

See below:
[Approvals and Compliances](#)

Description

- Shocksafe category PC3
- Captive Fuse-Carrier, Slotted or Fingergrip

Applications

- Medical Equipment

Weblinks

[pdf data sheet](#), [html datasheet](#), [General Product Information](#), [Distributor-Stock-Check](#), [Detailed request for product](#), [Microsite](#)

Technical Data

Shock-Safe Category	PC3
Fuse-Link	5 x 20 mm
Mounting	PCB
Terminal	Solder THT
Rated Voltage	250VAC
Rated current	6.3A (VDE), 10A (UL/CSA)
Rated Power Acceptance IEC	1.6W / 6.3A @ Ta 23°C Admissible power acceptance at higher ambient temperature see derating curves
Degree of Protection	IP40
Protection Class	Suitable for appliances with protection class I acc. to IEC 61140
Admissible Ambient Temp.	-40°C to 85°C
Climatic Category	40/085/21 acc. to IEC 60068-1
Material: Socket	Thermoplastic, black, UL 94V-0
Material: Terminals	Copper alloy, tin-plated
Storage Conditions	0°C to 60°C, max. 70% r.h.
Product Marking	 Rated Voltage, Power Rating, Rated current, Certification marks

Soldering Methods	Wave Soldering Profile
Solderability	235 °C / 3 sec acc. to IEC 60068-2-20, Test Ta, method 1
Resistance to Soldering Heat	260 °C / 10 sec acc. to IEC 60068-2-20, Test Tb, method 1A
Contact Resistance	≤ 10 mΩ at 100 mA acc. to IEC 60127-6
Dielectric Strength	> 3kV between live parts (50Hz: 1 min)
Impulse Withstand Voltage	> 4kV between live parts
Insulation Resistance	> 10 MΩ between live parts (500VDC: 1 min)
Overvoltage Category	II acc. to IEC 60664-1
Pollution Degree	2 acc. to IEC 60664-1

Approvals and Compliances



Detailed information on product approvals, code requirements, usage instructions and detailed test conditions can be looked up in [Details about Approvals](#)

SCHURTER products are designed for use in industrial environments. They have approvals from independent testing bodies according to national and international standards. Products with specific characteristics and requirements such as required in the automotive sector according to IATF 16949, medical technology according to ISO 13485 or in the aerospace industry can be offered exclusively with customer-specific, individual agreements by SCHURTER.

Approvals

The approval mark is used by the testing authorities to certify compliance with the safety requirements placed on electronic products.

Approval Reference Type: FBS2

Approval Logo	Certificates	Certification Body	Description
	VDE Approvals	VDE	VDE Certificate Number: 135561
	UL Approvals	UL	UR File Number: E39328



Product standards

Product standards that are referenced

Organization	Design	Standard	Description
	Designed according to	IEC 60127-6	Miniature fuses. Part 6. Fuse-holders for miniature fuse-links
	Designed according to	UL 4248-1	Industrial Control Equipment
	Designed according to	CSA C22.2 no. 4248.1	Industrial Control Equipment







Application standards

Application standards where the product can be used

Organization	Design	Standard	Description
	Suitable for applications acc.	IEC/UL 62368-1	Audio/video, information and communication technology equipment - Part 1: Safety requirements
	Suitable for applications acc.	IEC 60601-1	Medical electrical equipment - Part 1: General requirements for basic safety and essential performance

Compliances

The product complies with following Guide Lines

Identification	Details	Initiator	Description
	CE declaration of conformity	SCHURTER AG	The CE marking declares that the product complies with the applicable requirements laid down in the harmonisation of Community legislation on its affixing in accordance with EU Regulation 765/2008.
	UKCA declaration of conformity	SCHURTER AG	The UKCA marking declares that the product complies with the applicable requirements laid down in the British Amendment of Regulation (EC) 765/2008.
	RoHS	SCHURTER AG	Directive RoHS 2011/65/EU, Amendment (EU) 2015/863
	China RoHS	SCHURTER AG	The law SJ / T 11363-2006 (China RoHS) has been in force since 1 March 2007. It is similar to the EU directive RoHS.
	REACH	SCHURTER AG	On 1 June 2007, Regulation (EC) No 1907/2006 on the Registration, Evaluation, Authorization and Restriction of Chemicals 1 (abbreviated as "REACH") entered into force.
	Medical Equipment	SCHURTER AG	Suitable for use in medical equipment according to IEC/UL 60601-1 (1 MOOP, 1 MOPP)

Dimension [mm]

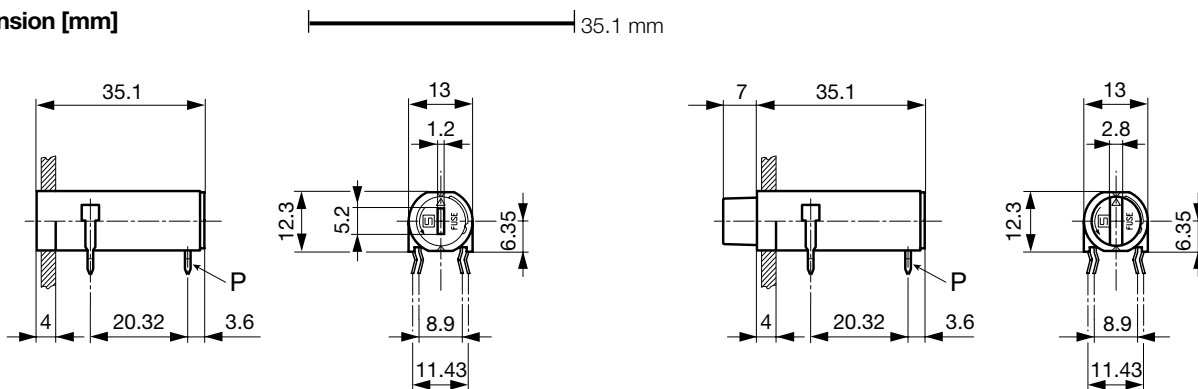

Variant 0031.3981

Variant Fingergrip 0031.3991



Drilling diagram

Mounting holes

Derating Curves

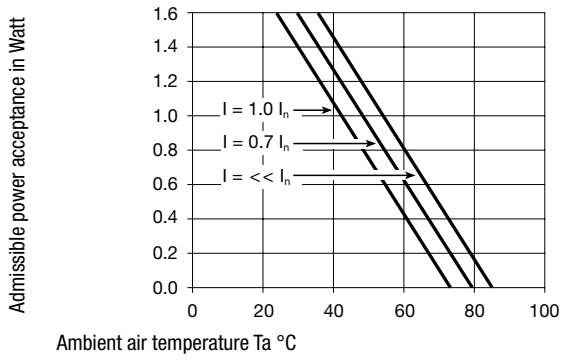

All Variants

Holder	Cap	Terminal	Degree of Protection	Order Number
●	slotted	kinked	IP40	0031.3981
●	Fingergrip	kinked	IP40	0031.3991

Most Popular.

Availability for all products can be searched real-time: <https://www.schurter.com/en/info-center/support-tools/stock-check-distributors>

Packaging Unit

Bulk (100 pcs.)