

IEC Appliance Inlet C14 with Fuseholder 1- or 2-pole



Snap-in version



See below:
[Approvals and Compliances](#)

Description

- Panel mount :
 Snap-in version front side
- 2 Functions :
 Appliance Inlet protection class I or II , Fuseholder for fuse-links 5 x 20 mm on the rear-side 1- or 2-pole
- Meets the requirements of IEC 60335-1 for appliances in unattended use. This includes the enhanced requirements of glow wire tests acc. to IEC 60695-2-11 or -12 &-13.

Characteristics

- Two "locking" snappers reinforce connector against repeated or excessive pull out force during plug removal
- All single elements are already wired
- Fuseholder on the inside of the equipment prevents accidental use of incorrect fuse-links by the user
- Suitable for use in equipment according to IEC/UL 62368-1

Other versions on request

- Ground terminal, solder/quick-connect, 90° to connector axis

References

Weblinks

[pdf data sheet](#), [html datasheet](#), [General Product Information](#), [Approvals](#), [Distributor-Stock-Check](#), [Accessories](#), [Detailed request for product](#)

Newly available variants corresponding to V-Lock mating cordset. The connector is equipped with a notch intended for use with the latching cordset. The cord latching system prevents against accidental removal of the cordset.

Technical Data

| | | | |
|-----------------------------------|---|-----------------------------------|--|
| Ratings IEC | 10A / 250VAC; 50Hz | Appliance inlet/-outlet | C14 / C18 acc. to IEC 60320-1, UL 498, CSA C22.2 no. 42 (for cold conditions) pin-temperature 70 °C, 10A, Protection Class I or II |
| Ratings UL/CSA | 10A / 125VAC; 60Hz | Fuseholder | 1-/2-pole, Shocksafe category PC2 acc. to IEC 60127-6, for fuse-links 5 x 20mm |
| Dielectric Strength | > 2.2kVAC between L-N > 3kVAC between L/N-PE (1 min/50Hz) | Rated Power Acceptance @ Ta 23 °C | 5 x 20: 3.15W (1 pole)/ 2.5W (2-pole) per pole |
| Allowable Operation Temperature | -25 °C to 70 °C | Power Acceptance @ Ta > 23°C | Admissible power acceptance at higher ambient temperature see derating curves |
| IP-Protection | front side IP40 acc. to IEC 60529 | | |
| Protection against electric shock | Suitable for appliances with protection class I or II acc. to IEC 61140 | | |
| Terminal | Quick connect terminals 4.8 x 0.8 mm , Ground terminal: Solder / Quick Connect tin-plated Solder terminal on request | | |
| Panel Thickness S | Snap-in: 1/1.2/1.5/2/2.5/3 mm (other on request) (all steps with one variant) | | |
| Material: Housing | Thermoplastic, black, UL 94V-0 | | |

Approvals and Compliances



Detailed information on product approvals, code requirements, usage instructions and detailed test conditions can be looked up in [Details about Approvals](#)

SCHURTER products are designed for use in industrial environments. They have approvals from independent testing bodies according to national and international standards. Products with specific characteristics and requirements such as required in the automotive sector according to IATF 16949, medical technology according to ISO 13485 or in the aerospace industry can be offered exclusively with customer-specific, individual agreements by SCHURTER.

Approvals





The approval mark is used by the testing authorities to certify compliance with the safety requirements placed on electronic products.

Approval Reference Type: GSF2

| Approval Logo | Certificates | Certification Body | Description |
|--|-------------------------------|--------------------|--|
|  | VDE Approvals | VDE | Certificate Number: 40024857 |
|  | UL Approvals | UL | UR File Number: E93617, E96454 |
|  | CCC Approvals | CCC | CCC Certificate Number: 2006010204183182 |



Product standards

Product standards that are referenced

| Organization | Design | Standard | Description |
|--|-----------------------|------------------|---|
|  | Designed according to | IEC 60320-1 | Appliance couplers for household and similar general purposes |
|  | Designed according to | IEC 60127-6 | Miniature fuses. Part 6. Fuse-holders for miniature fuse-links |
|  | Designed according to | IEC 61058-1 | Switches for appliances. Part 1. General requirements |
|  | Designed according to | UL 498 | Standard for Attachment Plugs and Receptacles |
|  | Designed according to | CSA C22.2 no. 42 | General Use Receptacles, Attachment Plugs, and Similar Wiring Devices |







Application standards

Application standards where the product can be used

| Organization | Design | Standard | Description |
|--|--------------------------------|----------------|--|
|  | Suitable for applications acc. | IEC/UL 62368-1 | Audio/video, information and communication technology equipment - Part 1: Safety requirements |
|  | Suitable for applications acc. | IEC 60335-1 | Safety of electrical appliances for household and similar purposes. Meets the requirements for appliances in unattended use. This includes the enhanced requirements of glow wire tests acc. to IEC 60695-2-11 or -12 & -13. |

Compliances

The product complies with following Guide Lines

| Identification | Details | Initiator | Description |
|--|--|-------------|--|
|  | CE declaration of conformity | SCHURTER AG | The CE marking declares that the product complies with the applicable requirements laid down in the harmonisation of Community legislation on its affixing in accordance with EU Regulation 765/2008. |
|  | UKCA declaration of conformity | SCHURTER AG | The UKCA marking declares that the product complies with the applicable requirements laid down in the British Amendment of Regulation (EC) 765/2008. |
|  | RoHS | SCHURTER AG | Directive RoHS 2011/65/EU, Amendment (EU) 2015/863 |
|  | China RoHS | SCHURTER AG | The law SJ / T 11363-2006 (China RoHS) has been in force since 1 March 2007. It is similar to the EU directive RoHS. |
|  | REACH | SCHURTER AG | On 1 June 2007, Regulation (EC) No 1907/2006 on the Registration, Evaluation, Authorization and Restriction of Chemicals 1 (abbreviated as "REACH") entered into force. |
|  | | SCHURTER AG | V-Lock system are based on a matching plug-dose combination. The connector is equipped with a notch intended for use with the latching cordset. The cord latching system prevents against accidental removal of the cordset. |
|  | White Paper Glow wire test | SCHURTER AG | Meets the requirements of IEC 60335-1 for appliances in unattended use. This includes the enhanced requirements of glow wire tests acc. to IEC 60695-2-11 or -12 & -13. |

Dimensions [mm]

punched / drilled

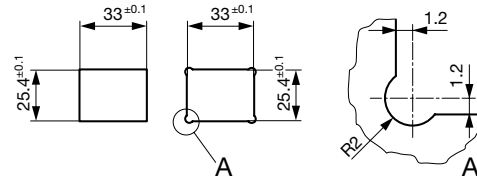
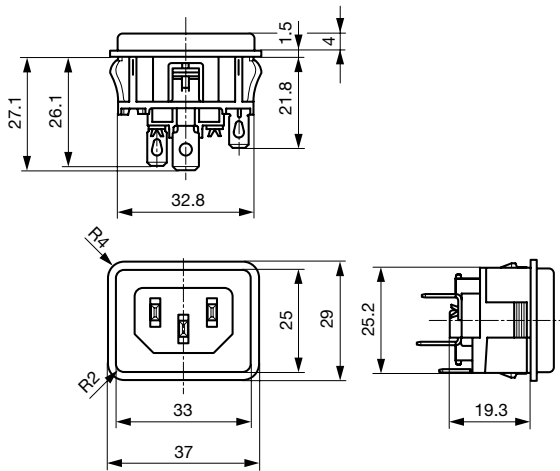

Line and neutral: Quick-connect
 Quick connect terminal 4.8 x 0.8
 mm

Ground terminal
 Quick connect terminal 4.8 x 0.8
 mm

Ground terminal: Quick-connect
 Quick connect terminal 6.3 x 0.8
 mm

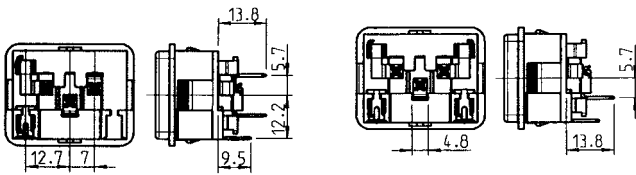

Assembly Instructions

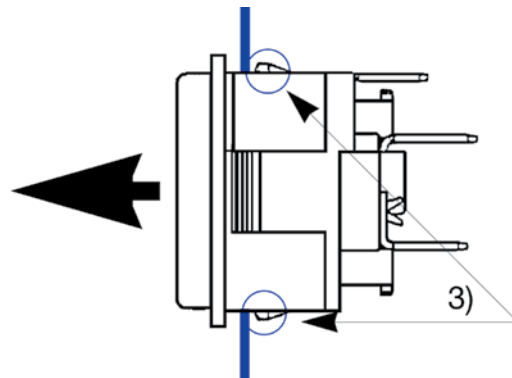
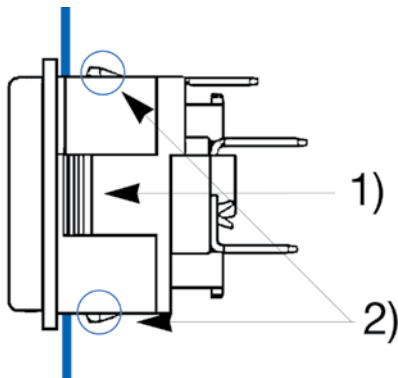

1) Main snappers for snap-in mounting
 2) Additional safety snappers not in use

3) Additional safety snappers in use
 against excessive pull out force

Derating Curves

1-pole

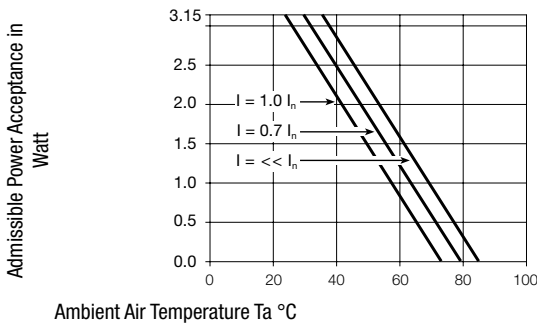

2-pole

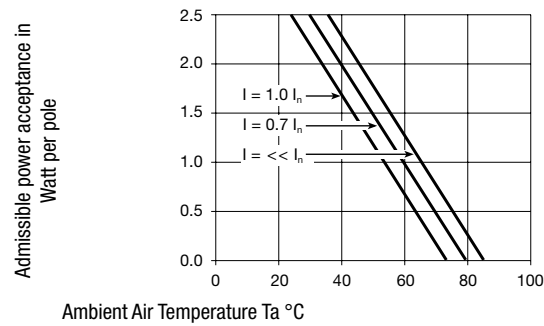

All Variants

| Protection Class | Fuseholder | Terminals L / N | | Ground terminal | | V-Lock | Order Number |
|------------------|------------|--------------------------------------|-----------------------|--------------------------------------|-----------------------|--------|--------------|
| | | Connection type | Terminal direction | Connection type | Terminal direction | | |
| I | - | Quick connect terminals 4.8 x 0.8 mm | in line with PIN-axis | Quick connect terminals 4.8 x 0.8 mm | in line with PIN-axis | | GSF2.0011.01 |
| I | 1-pole | Quick connect terminals 4.8 x 0.8 mm | in line with PIN-axis | Quick connect terminals 4.8 x 0.8 mm | in line with PIN-axis | | GSF2.1011.01 |
| I | 1-pole | Quick connect terminals 4.8 x 0.8 mm | in line with PIN-axis | Quick connect terminals 6.3 x 0.8 mm | in line with PIN-axis | | GSF2.1013.01 |
| I | 1-pole | Quick connect terminals 4.8 x 0.8 mm | 90° to connector axis | Quick connect terminals 4.8 x 0.8 mm | 90° to connector axis | | GSF2.1022.01 |
| I | 2-pole | Quick connect terminals 4.8 x 0.8 mm | in line with PIN-axis | Quick connect terminals 4.8 x 0.8 mm | in line with PIN-axis | | GSF2.2011.01 |
| I | 2-pole | Quick connect terminals 4.8 x 0.8 mm | in line with PIN-axis | Quick connect terminals 6.3 x 0.8 mm | in line with PIN-axis | | GSF2.2013.01 |
| I | 2-pole | Quick connect terminals 4.8 x 0.8 mm | 90° to connector axis | Quick connect terminals 4.8 x 0.8 mm | 90° to connector axis | | GSF2.2022.01 |
| II | 1-pole | Quick connect terminals 4.8 x 0.8 mm | in line with PIN-axis | - | - | | GSF2.1010.01 |
| II | 2-pole | Quick connect terminals 4.8 x 0.8 mm | in line with PIN-axis | - | - | | GSF2.2010.01 |

Most Popular.

Availability for all products can be searched real-time: <https://www.schurter.com/en/info-center/support-tools/stock-check-distributors>

Packaging unit

50 Pcs

Mating Outlets/Connectors

Category / Description

[Connector Overview complete](#)



| | |
|---|---------|
| 4782 Mounting: Power Cord, 3 x 1 mm ² / 3 x 18 AWG, Cable, Connector: IEC C13 | 4782 |
| 4785 Mounting: Power Cord, 3 x 1 mm ² / 3 x 18 AWG, Cable, Connector: IEC C13 | 4785 |
| 4300-06 Mounting: Power Cord, 3 x 1 mm ² / 3 x 18 AWG, Cable, Connector: IEC C13 | 4300-06 |
| 4781 Mounting: Power Cord, Cable, Connector: IEC C15 | 4781 |
| 4784 Mounting: Power Cord, 3 x 1 mm ² / 3 x 18 AWG, Cable, Connector: IEC C15 | 4784 |

[Interconnection Cord Overview complete](#)



| | |
|--|-----------|
| Cord Sets 10 A, Interconnection, 2.0 m, IEC H05VV-F3G1.0, black | 6007.0204 |
| Cord Sets 10 A, Interconnection, 1.0 m, Connector IEC C13, H05VV-F3G1.0, black | 6007.0212 |
| Cord Sets 10 A, Interconnection, 2.0 m, Connector IEC C13, H05VV-F3G1.0, black | 6007.0214 |

[Power Supply Cord Overview complete](#)



| | |
|--|-----------|
| Cord Sets 10 A, Europlug, 2.5 m, Connector IEC C13, H05VV-F3G1.0, black | 6004.0215 |
| Cord Sets 10 A, Europlug, 2.5 m, Connector IEC C13, H05VV-F3G1.0, black | 6003.0215 |
| Cord Sets 10 A, uninsulated wires, 2.0 m, Connector IEC C13, H05VV-F3G1.0, black | 6000.0224 |
| Cord Sets 10 A, uninsulated wires, 2.0 m, Connector IEC C13, H05VV-F3G1.0, black | 6000.0214 |
| Cord Sets 10 A, United Kingdom, 2.5 m, Connector IEC C13, H05VV-F3G1.0, black | 6044.0215 |

...

[Power Supply or Interconnection Cord Overview complete](#)



| | |
|--|-----------|
| Cord Sets 10 A, United Kingdom, 2.0 m, Connector IEC H05VV-F3G1.0, black | 6044.0204 |
|--|-----------|

Mating Outlets/Connectors shuttered

[Connector Overview complete](#)



| | |
|--|------|
| 4783 Mounting: Power Cord, 3 x 1 mm ² / 3 x 18 AWG, Cable, Connector: IEC C13 | 4783 |
|--|------|

[Power Cord Overview complete](#)



| | |
|---|---------|
| VAC13KS, Overview, V-Lock cord retaining, diverse Connector IEC C13, diverse, black | VAC13KS |
| VAC17KS, V-Lock cord retaining, diverse m, Connector IEC C17, diverse, black / grey / white | VAC17KS |