

Piezo Switch N.O.



Red ring illumination  
 Aluminum  
 with wires (stranded)  
 PSE M24 RI red



Multicolor  
 Aluminum  
 with wires (stranded)  
 PSE M24 RI RGB

See below:

[Approvals and Compliances](#)

**Description**

- Available in version Standard, lettered, with Point Illumination or Ring Illumination
- RGB, RGY: flexible input voltage from 5 - 28 VDC at constant brightness
- With color combination RGB and RGY
- 7 possible colors with RGB configuration
- 3 possible colors with RGY configuration Assembly by mounting with nut
- Pins / Wire / Crimp Terminal male / Cable with Faston

**Unique Selling Proposition**

- Variety of design options regarding size, colour, shape, connection or lettering
- High reliability, long lifetime with more than 20 mill. actuations
- With RGB or RGY ring illumination

**Characteristics**

- Housing material types: aluminum or stainless steel, ring illuminated version additionally made of polyamide
- For use in harsh environments, both indoors and outdoors (see technical data)

**Other versions on request**

- Switch for longer switching signal duration, type: PSE IV
- Switch for explosion proof applications, type: PSE EX
- Switch with enhanced vandal proof protection, type: PSE HI

**References**

- Alternative: switch vandal improved: [PSE HI 22](#)
- Alternative: switch for EX-proof applications: [PSE HI 22](#)
- Alternative: Other diameter [PSE with cable](#); [PSE NO 16](#); [PSE NO 19](#); [PSE NO 22](#)
- Alternative: Other diameter
- Alternative: switch with prolonged signal: [PSE AE 16](#); [PSE AE 30](#)

**Weblinks**

- [pdf data sheet](#), [html datasheet](#), [General Product Information](#), [CAD-Drawings](#), [Product News](#), [Detailed request for product](#), [Microsite](#)

**Technical Data**

**Electrical Data**

Switching Function	momentary
Supply Voltage	24 VDC Ring Illumination 24 VDC Point Illumination 5 VDC and 12 VDC variants on request (MOQ 500 pieces)
Supply Voltage RGB	5 - 28 VDC
Switching Voltage	max. 42 / 60 VAC/DC
Switching current	max. 100 mA
Electrical Rating	1 W
Lifetime	20 million actuations at Rated Switching Capacity
Switch Resistance OFF	> 10 MΩ
Switch Resistance ON	< 20Ω actuated (Ta = 25°C)
Capacity	5 nF
N.O. Closing Impulse Duration	20- 1000 ms depending on actuating force, time and speed
Contact Configuration	free polarity
<b>RGB Illumination</b>	
Current Consumption (max per color)	16.5 mA @ 5 VDC 8.2 mA @ 12 VDC 5.5 mA @ 24 VDC 4.8 mA @ 28 VDC

**Mechanical Data**

Actuating Force	≤ 3 N at ambient temperature
Actuating Travel	0.002 mm
Shock Protection	IK02
Mounting screw torque	2.5 Nm

**Climatical Data**

Operating Temperature	-40 to 85 °C
Storage Temperature	-40 to 85 °C
IP-Protection	IP67 acc. to IEC 60529, IP69K acc. to DIN 40050-9
Environmental Assessment	+55°C / 93% r.h. acc. to DIN EN 60068-2-30
Salt Spray Test (acc. to DIN 50021-SS)	24 h / 48 h / 96 h Residence Time

**Material**

Housing (depending on type)	Stainless Steel, Aluminum anodized
Actuating Area / Insert (with Ring Illumination)	Stainless Steel, Aluminum anodized
Illuminated Ring (Ring Illumination)	Polyamide





**Approvals and Compliances**

Detailed information on product approvals, code requirements, usage instructions and detailed test conditions can be looked up in [Details about Approvals](#)

SCHURTER products are designed for use in industrial environments. They have approvals from independent testing bodies according to national and international standards. Products with specific characteristics and requirements such as required in the automotive sector according to IATF 16949, medical technology according to ISO 13485 or in the aerospace industry can be offered exclusively with customer-specific, individual agreements by SCHURTER.





### Application standards

Application standards where the product can be used

Organization	Design	Standard	Description
	Suitable for applications acc.	EMC Directive:	EMC directive 2014/30/EU
	Suitable for applications acc.	MIL-STD:	202F Method 107G, 202F Method 204D, 202F Method 213B, 416D Method RS103, 810E Method 501.3, 810E Method 502.3, 810E Method 507.3
	Suitable for applications acc.	VDE Certificate Number:	DIN EN 61000-4-2, DIN EN 61000-4-4, DIN EN 61000-4-5
	Suitable for applications acc.	IEC/UL 62368-1	Audio/video, information and communication technology equipment - Part 1: Safety requirements

### Compliances

The product complies with following Guide Lines

Identification	Details	Initiator	Description
	<a href="#">CE declaration of conformity</a>	SCHURTER AG	The CE marking declares that the product complies with the applicable requirements laid down in the harmonisation of Community legislation on its affixing in accordance with EU Regulation 765/2008.
	<a href="#">UKCA declaration of conformity</a>	SCHURTER AG	The UKCA marking declares that the product complies with the applicable requirements laid down in the British Amendment of Regulation (EC) 765/2008.
	RoHS	SCHURTER AG	Directive RoHS 2011/65/EU, Amendment (EU) 2015/863
	REACH	SCHURTER AG	On 1 June 2007, Regulation (EC) No 1907/2006 on the Registration, Evaluation, Authorization and Restriction of Chemicals 1 (abbreviated as "REACH") entered into force.

### Dimension [mm]

PSE M24 RI

PSE M24 RI RGB with wires and with finger guidance

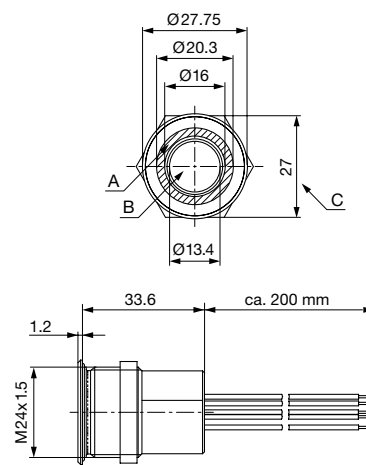
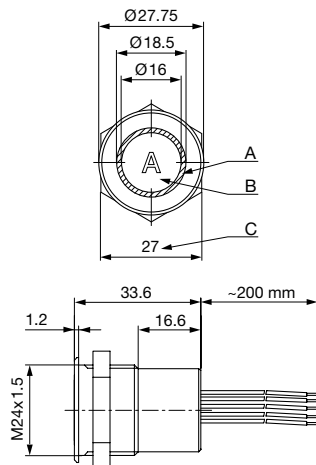

Design actuating area

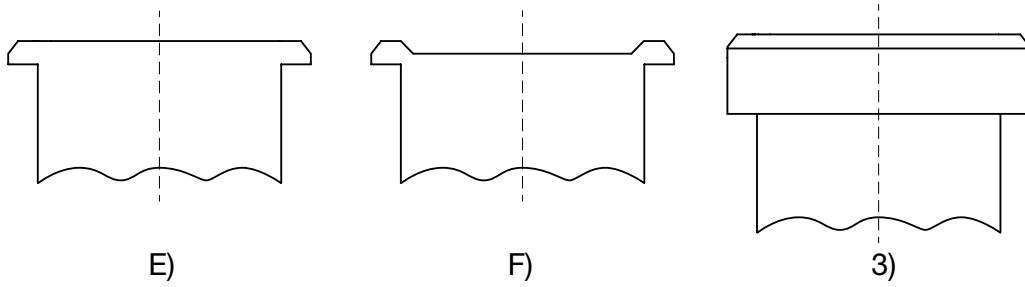

Legend:

- A = Illumination Area
- B = Actuating Area
- C = Width Across Flats
- I = Crimp Terminal male 6.3 x 0.8
- PI = Point Illumination
- RI = Ring Illumination

Lettering:

- either with/without lettering
- position of the connections with respect to the position of the lettering is not defined

- F) with finger guidance
- E) without finger guidance
- 3) elevated front design: M19 (standard, others on request)

---

**Dimension**

PSE M24

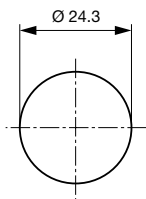

Drilling diagram

---

Diagrams

PSE M24 RI / PSE M27 RI / PSE M30 RI, 12/24 V

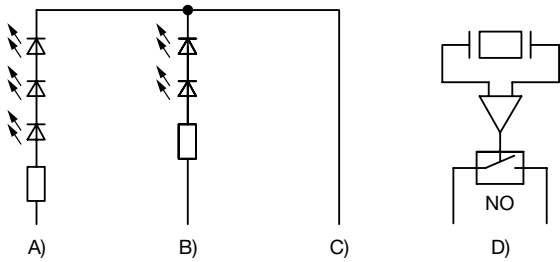

- A) Cable 1 (color of the LEDs), Supply voltage first LED group
- B) Cable 3 (color of the LEDs), Supply voltage second LED group
- C) Cable 2 (black), Common mass of both LED groups
- D) Cable 4 and 5 (white), Input and output PSE switch

PSE M24 RI / PSE M27 RI / PSE M30 RI, 5 V

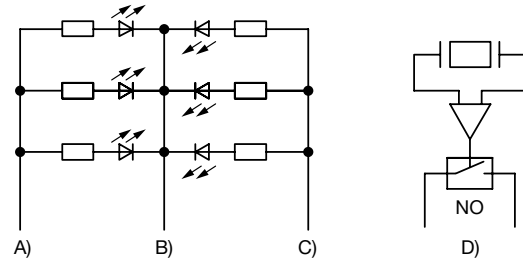

- A) Cable 1 (color of the LEDs), Supply voltage first LED group
- B) Cable 2 (black), Common mass of both LED groups
- C) Cable 3 (color of the LEDs), Supply voltage second LED group
- D) Cable 4 and 5 (white), Input and output PSE switch

PSE M22 / M30 RI RGB

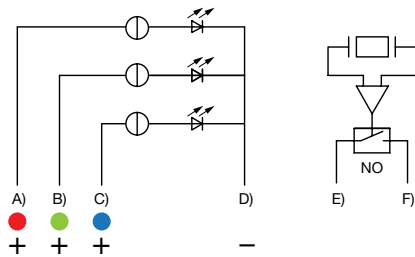

- A) Cable 1 (color of the LED), Supply voltage
- B) Cable 2 (color of the LED), Supply voltage
- C) Cable 3 (color of the LED), Supply voltage
- D) Cable 4 (black), Common mass
- E) Cable 5/6 (white), Input and output PSE switch
- F) Cable 5/6 (white), Input and output PSE switch

Illumination options for RGB

Lighting type	Active terminal A) <span style="color: red;">●</span>	Active terminal B) <span style="color: green;">●</span>	Active terminal C) <span style="color: blue;">●</span>	Resulting Color
Multicolor Singlecolor	A			Red <span style="color: red;">●</span>
Multicolor Singlecolor		B		Green <span style="color: green;">●</span>
Multicolor Singlecolor			C	Blue <span style="color: blue;">●</span>
Multicolor RGB Additive 2	A	B		Yellow <span style="color: yellow;">●</span>
Multicolor RGB Additive 2	A		C	Magenta <span style="color: magenta;">●</span>
Multicolor RGB Additive 2		B	C	Cyan <span style="color: cyan;">●</span>
Multicolor RGB Additive 3	A	B	C	White <span style="color: white;">○</span>

Marking

The last three digits in the order number define the lettering:

001-076	Standard Lettering
101-	Customized Lettering

Lettering - Aluminium / Plastic Material
Lettering - Stainless Steel

Lettering Colour of Laser Lettering

Material	Lettering Colour	
Stainless Steel	black	Filled letters
Aluminum natural anodized	light grey	Filled letters (only after customer approval)
Aluminum coloured anodized	light grey	Filled letters

### Order Index Lettering

Laser Marking			
001 =A	021 =U	041 =÷	061 =EIN
002 =B	022 =V	042 =*	062 =AUS
003 =C	023 =W	043 ==	063 =AUF
004 =D	024 =X	044 =#	064 =AB
005 =E	025 =Y	045 =↔	065 =ON
006 =F	026 =Z	046 =↑	066 =OFF
007 =G	027 =0	047 =→	067 =UP
008 =H	028 =1	048 =←	068 =DOWN
009 =I	029 =2	049 =↓	069 =HIGH
010 =J	030 =3	050 =↑	070 =LOW
011 =K	031 =4	051 =%	071 =ON/OFF
012 =L	032 =5	052 =√	072 =START
013 =M	033 =6	053 =CTRL	073 =RESET
014 =N	034 =7	054 =RETURN	074 =
015 =O	035 =8	055 =SHIFT	075 =
016 =P	036 =9	056 =LOCK	076 =
017 =Q	037 =+	057 =STOP	077 =
018 =R	038 =-	058 =ENTER	
019 =S	039 =.	059 =BACK	
020 =T	040 =x	060 =LINE	

Please note that the font size depends on the number of characters

### All Variants

Mounting Diameter	Terminal	Housing Material, Torsion Protection	Colour of Housing	Actuator area	Illumination, LED	Config. Code	Order Number
24	Flexible wire	Aluminum ,no	Alu natural	F	RI dotted, red / green, 24 VDC	PSE M 24 NO RI	1241.3010
24	Flexible wire	Aluminum ,no	Alu natural	F	RI homogeneous, RGB, 5 - 28 VDC	PSE M 24 NO RI	1241.3665

Nut with gasket are enclosed in the box.

Other mounting diameters, materials, colors, connections, supply voltages possible available on request.  
 Special materials e.g. Marine grade stainless steel for use in salt and chlorinated environment on request.

The MOQ for standard laser lettering on standard variants is a packing unit.

Most Popular.

Availability for all products can be searched real-time: <https://www.schurter.com/en/info-center/support-tools/stock-check-distributors>

Legend:

Type: PSE

NO = normally open

IV = prolonged signal

RU = PI = Point Illumination

RI = Ring Illumination

LE = Lettered

K = Plastics

Alu = Aluminium

ES = Stainless steel

F = Finger guidance

E = without finger guidance

**Packaging unit**

10 in box with insert or packed in air cushion bags



- Actuating elements in ESD safe packaging
- Screw nuts and sealing O-ring in a bag (enclosed in the box)

**Accessories**

**Description**



[Connecting\\_Terminal\\_PSE](#)  
 Connecting Terminal



[Power\\_Supply](#)  
 Power Supply IP42 for LED- and Illumination applications indoor 90~264 VAC => 24 VDC 0.34 A 8 W